

SPECIFICATION

	L-2000
Temperature range	600~2000[°C]
Element	InGaAs, Si (2 Color)
Wavelength	1.6[μm], 0.9[μm]
Accuracy rating	±1[%] ε = 1.0
Repeatability	±1[%] ε = 1.0
Resolution	1[°C]
Measured value display	7segLED Character quantity 14.6[mm]
Preset value display	7segLED Character quantity 10.1[mm]
Response time	0.05[sec]
Compensation range	0.050~1.200
Setting	Key operation in front panel
Analog output	DC 0~10[V], 4~20[mA] load resistance 470[Ω] or low
Alarm output	Open collector output Hi, Lo(standard) MAX DC 30[V] 50[mA] Relay output Hi, Lo(option) Contact arrangement 1a, AC 250[V]8[A], DC 30[V]5[A]
Communication	RS-232 Start-stop synchronization 4800/9600/19200/38400[bps], 7/8bit, 1/2stop-bit
Power supply	AC 85~264[V] 15[W]
Working temperature	10~50[°C] No dew condensation
Outside dimension	96×72×165 [mm]
Weight	1.5[kg] (Only L-2000)

ORDER

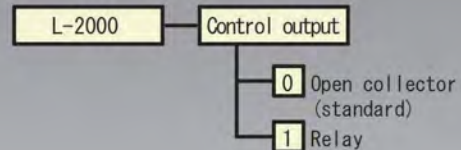

※Please choose a sensor head and optical fiber cable from the following table.

CONTENTS OF COMPOSITION

- ① L-2000
- ② Sensor head
- ③ Optical fiber cable

SENSOR HEAD

	Models
Fixed focus type	SH-25A SH-25C-40
	SH-25B
	SH-25D
Movable focal type	SH-7A-64 SH-7C-60
	SH-7A-77
	SH-7B-113

OPTICAL FIBER CABLE

	Standard	With SUS protective tube	Y type
1.5 m	F05ST-1.5	F05SS-1.5	F05Y-1.5
2.0 m	F05ST-2.0	F05SS-2.0	F05Y-2.0
3.0 m	F05ST-3.0	F05SS-3.0	F05Y-3.0
5.0 m	F05ST-5.0	F05SS-5.0	F05Y-5.0

※ Please ask us, when the length of an optical fiber cable needs what is not in the upper table.

OPTION

QCF-25H	LA-1B	LA-1G	U-8000	SL-68G	ANC-L
QCF-7H (A/B) (C)					
Air purge unit	Camera platform for head		Tripod		Analog cable

OPTICAL FIBER TYPE 2 COLOR THERMOMETER

L-2000



TASHIKA CO., LTD.

1-12, Kaiyo-cho, Ashiya-shi, Hyogo 659-0035, JAPAN

Tel: + 81-797-23-9035 Fax: + 81-797-23-2105

e-mail: sales@tashika.co.jp URL: www.tashika.co.jp

TASHIKA - JAPAN

L-2000 CAN BE USED ON SPECIAL CONDITIONS

L-2000 is the thermometer which adopted two kinds of sensors which have sensitivity in the wavelength from which InGaAs and Si differ and which measures two colors. By using two kinds of sensors, measurement became possible also on the conditions shown below.
 1. View becomes narrow. 2. Particulates, 3. Smoke, 4. Through glass
 L-2000 can react at high speed (0.05 sec). Please realize this speed.

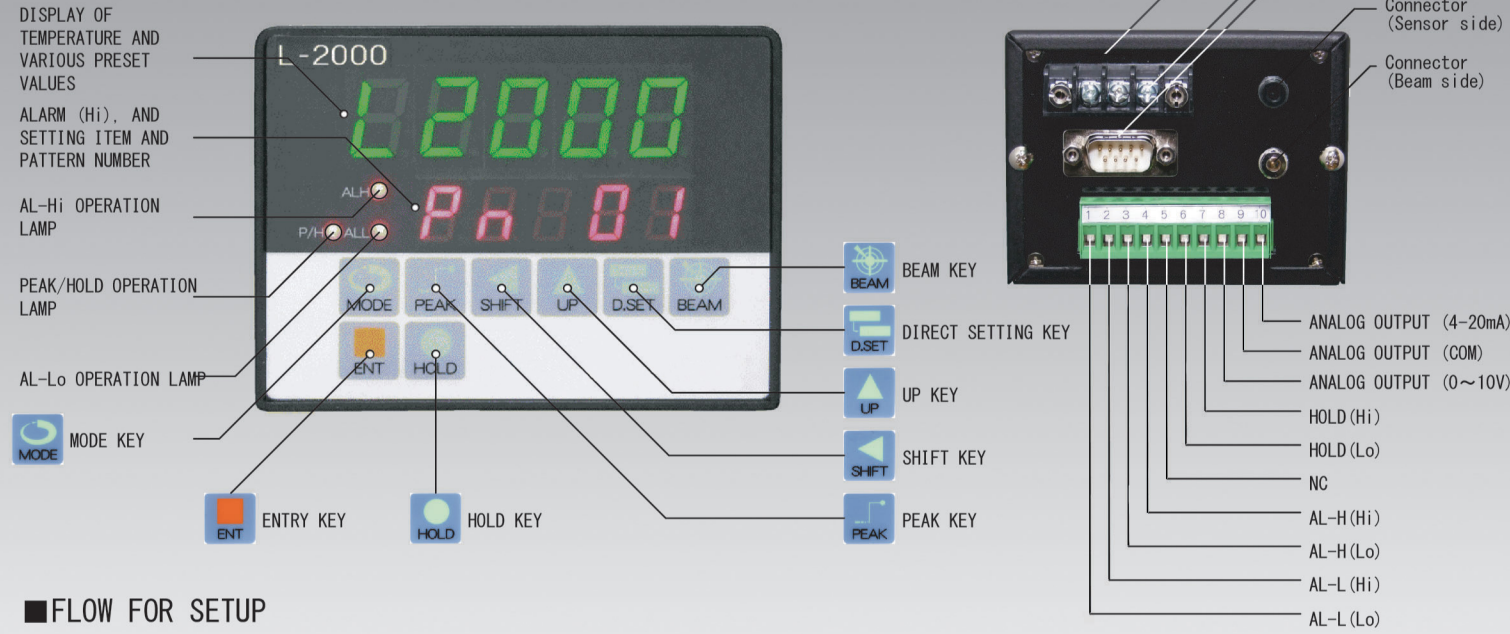

FLOW FOR SETUP

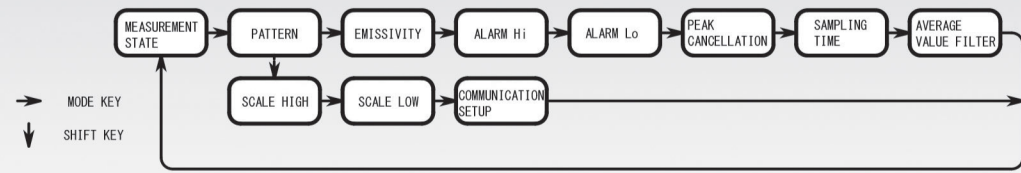

FEATURE

- It is hard to be affected by the influence of the view which becomes small, particulates, smoke, over [unclean] glass etc.
- The speed which L-2000 can detect is the fastest and 0.05 second.
- Measurement to a minute area whose minimum diameter is 0.2 mm is possible for L-2000.
- 600~2000 °C wide range.
- It is also possible to measure temperature on condition of through glass.

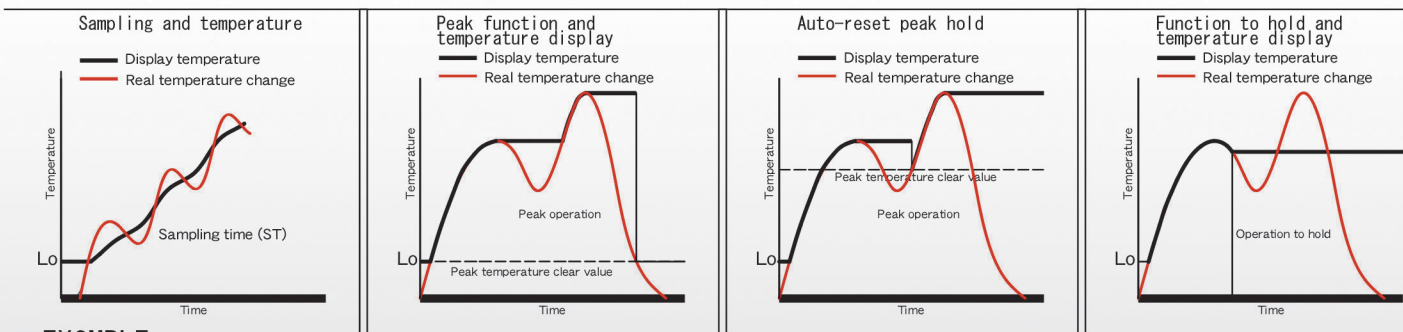
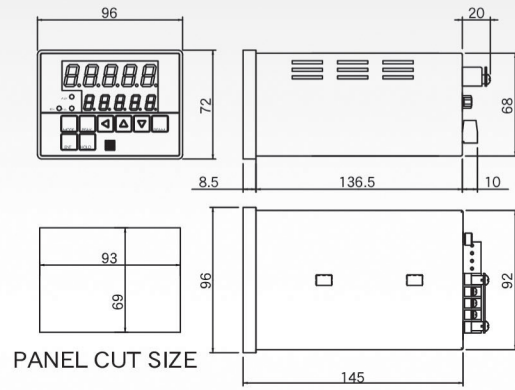

EXSMPL

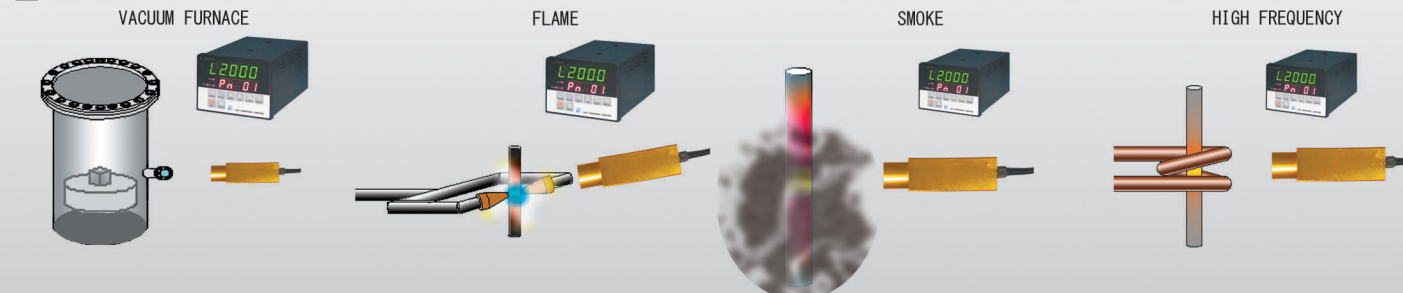

OPTICAL FIBER FIXED FOCUS TYPE

SH-25A

Middle-distance minute area

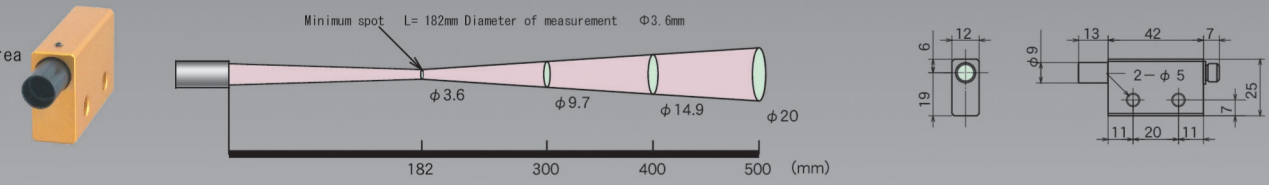

SH-25B

Short-distance minute area

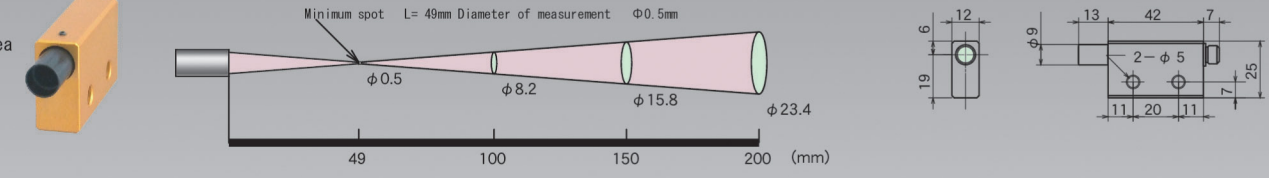

SH-25C-40

Middle-distance minute area

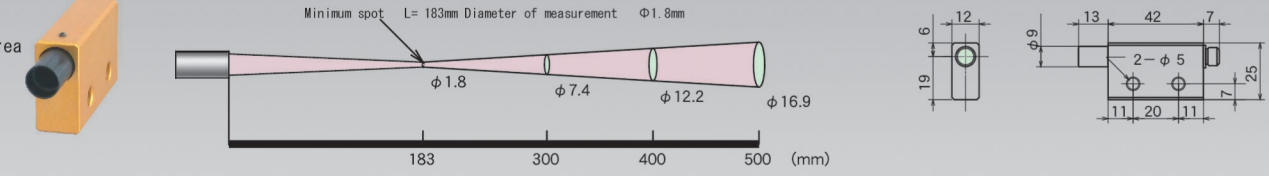

SH-25D

Middle-distance minute area

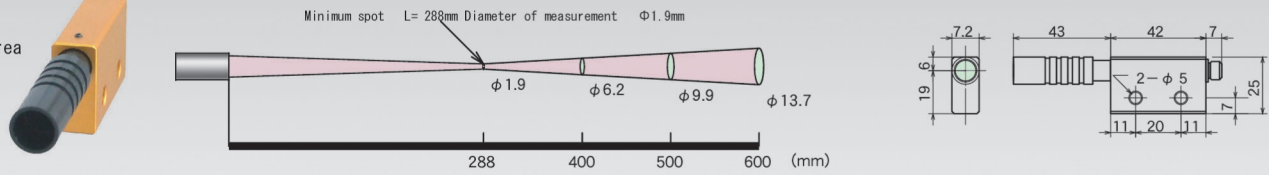

OPTICAL FIBER MOVABLE FOCAL TYPE

SH-7A-64/77

Short-distance minute area

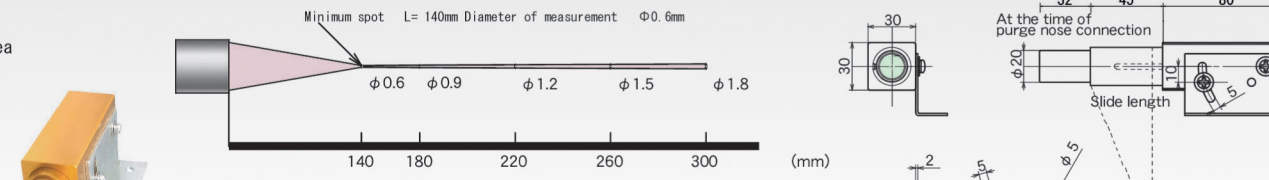

Middle-distance minute area

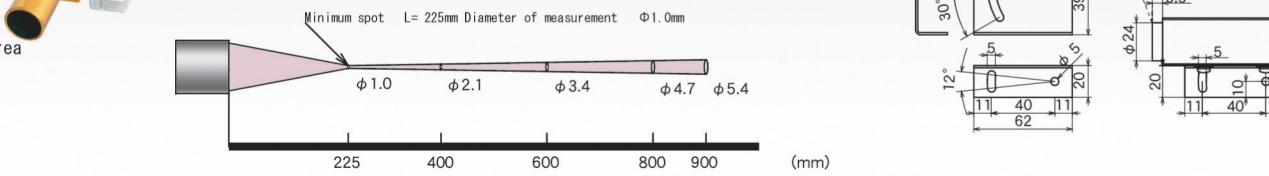

SH-7B-113

Middle-distance minute area

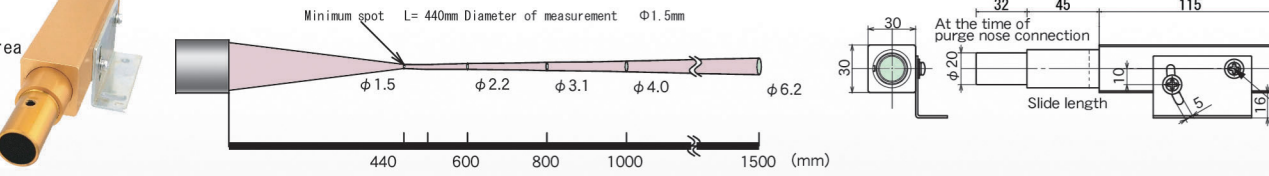

SH-7C-60

Short-distance minute area

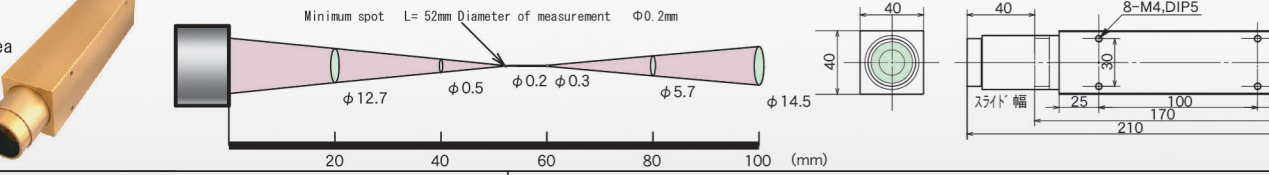

OPTICAL FIBER CABLE

Optical fiber cable F05ST and F05SS of a single core do again and use connection from the connector side for sensors to the connector side for beams.
 When exchange of an optical fiber cable is difficult conditions after attaching a main part, I recommend adopting an F05Y optical fiber cable. In the case of a fixed focus type sensor head, the distance which beam light can check clearly is measurement distance (measurement point). The case of a movable focus makes the optical lens which exists at the tip of a sensor head slide with a holder, and adjusts a focus. The size of the area which beam light illuminates according to measurement distance changes.

F05ST (standard)



F05SS (With stainless steel protective tube)

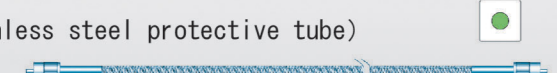

F05Y (Optical fiber unifies measurement, and beams)

